

Dell™ PowerVault™  
Network Attached Storage  
(NAS) Solution  
**iSCSI Deployment Guide**

# Notes, Cautions, and Warnings



**NOTE:** A NOTE indicates important information that helps you make better use of your computer.



**CAUTION:** A CAUTION indicates potential damage to hardware or loss of data if instructions are not followed.



**WARNING:** A WARNING indicates a potential for property damage, personal injury, or death.

---

**Information in this document is subject to change without notice.**

© 2009 Dell Inc. All rights reserved.

Reproduction of these materials in any manner whatsoever without the written permission of Dell Inc. is strictly forbidden.

Trademarks used in this text: *Dell*, the *DELL* logo, and *PowerVault* are trademarks of Dell Inc.; *Microsoft*, *Windows*, and *Windows Server* are either trademarks or registered trademarks of Microsoft Corporation in the United States and/or other countries.

Other trademarks and trade names may be used in this document to refer to either the entities claiming the marks and names or their products. Dell Inc. disclaims any proprietary interest in trademarks and trade names other than its own.

# Contents

1	Introduction . . . . .	7
	<b>Terms and Definitions . . . . .</b>	<b>8</b>
	PowerVault Storage System . . . . .	8
	iSCSI . . . . .	8
	iSNS. . . . .	8
	<b>Before Setting Up the PowerVault Storage Solution as an iSCSI Target. . . . .</b>	<b>9</b>
	Best Practices for Setting Up the iSCSI Storage Area Network. . . . .	9
2	Setup Steps for Initiator-Target Connection . . . . .	13
	Pre-Requisites . . . . .	13
	<b>Method 1 (Discovery Using Target Portals). . . . .</b>	<b>13</b>
	Configuring the Initiator (Host) . . . . .	14
	Configuring iSCSI Connection With the PowerVault NAS Storage System . . . . .	14
	Creating the Target . . . . .	14
	Creating a Virtual Disk . . . . .	16
	Log on - Configuring the Initiator-Target Connection From Initiator (Host) . . . . .	17
	<b>Method 2 (Discovery Using iSNS Server). . . . .</b>	<b>18</b>
	Pre-Requisites . . . . .	18
	Configuring Settings From the Initiator . . . . .	18

3	Target Details . . . . .	21
	<b>Setting Up Target IP Addresses in the PowerVault™ NAS Storage Solution</b> . . . . .	21
	Configuring Microsoft® iSCSI Software Targets . . . . .	21
	Configuring iSCSI LUNs. . . . .	26
	Multiple Sessions. . . . .	27
	iSCSI Snapshots . . . . .	27
	<b>Disconnecting/Cleaning Up iSCSI Devices</b> . . . . .	32
	From Initiator . . . . .	32
	From Target . . . . .	32
4	Configuring Secured iSCSI Connections Using Challenge-Handshake Authentication Protocol . . . . .	35
	<b>CHAP vs IPsec</b> . . . . .	36
	<b>One-Way CHAP Authentication</b> . . . . .	36
	iSCSI Target Settings . . . . .	36
	iSCSI Initiator Settings . . . . .	37
	<b>Mutual CHAP Authentication</b> . . . . .	37
	Initiator Settings . . . . .	37
	Target Settings . . . . .	38
	Initiator Settings Continued. . . . .	38
A	Appendix . . . . .	39
	<b>Initiator Details.</b> . . . . .	39
	General Tab . . . . .	39
	Discovery Tab. . . . .	40
	Targets Tab . . . . .	42

<b>Advanced Configuration Details</b> . . . . .	<b>45</b>
Enabling Multi-Path on the Initiator . . . . .	45
Using the Advanced Option . . . . .	46
Verifying the Properties of the Targets that are Connected . . . . .	46
<b>Installing and Configuring iSNS Server.</b> . . . . .	<b>48</b>
Configuring the iSNS Server . . . . .	49
<b>Best Practices for Efficient Storage Management</b> . . .	<b>50</b>
Storage Manager for SANs . . . . .	50
LUN Management for iSCSI Subsystems. . . . .	50
<b>Known Issues</b> . . . . .	<b>51</b>



# Introduction

This document provides information about configuring the Internet Small Computer System Interface (iSCSI) Software Target on the Dell™ PowerVault™ storage system as a block storage device.

iSCSI is a useful and relatively inexpensive way to provide storage for new applications or to provide a network pool of storage for existing applications. Dell and its storage partners provide a variety of storage solutions that can be implemented easily. This document allows administrators and IT managers to explore iSCSI technology and see actual deployment examples.

The following topics are discussed in the document:

- Quick install steps—Provides instructions about creating an iSCSI Target and establishing connection with a Microsoft® iSCSI Initiator
- End-to-end iSCSI configuration:
  - Detailed instructions on installing and configuring the Microsoft iSCSI Initiator software and the Microsoft iSCSI Software Target
  - Configuring the Initiator-Target connections
- Setting up secure iSCSI connections
- Microsoft iSNS server and other advanced configuration details



**NOTE:** In this document the iSCSI Initiator is referred to as the *Initiator* and the iSCSI Software Target is referred to as the *Target*.

# Terms and Definitions

The following sections describe the terms used in this document.

## PowerVault Storage System

Throughout this document, the term *PowerVault storage system* refers to the individual storage unit. The term *PowerVault storage solution* refers to the configuration of the server separately or together with the storage arrays.

## iSCSI

iSCSI is a standard that carries SCSI commands through Transfer Control Protocol/Internet Protocol (TCP/IP)—a protocol that enables transport of block data over IP networks, without the need for a specialized network infrastructure, such as Fibre Channel.

In the context of system storage, iSCSI enables any client/machine (Initiator) on an IP network to contact a remote dedicated server (Target) and perform block I/O on it just as it would perform on a local hard disk.

## iSNS

Microsoft iSCSI Internet Storage Name Service (iSNS) is a service that processes iSNS registrations, deregistrations, and queries through TCP/IP from iSNS clients and also maintains a database of these registrations (similar to a DNS server). A common use for Microsoft iSNS server is to allow iSNS clients (Initiators and Targets) to register themselves and to query for other registered iSNS clients. Registrations and queries are transacted remotely over TCP/IP.

You can download and install the iSNS server from the Microsoft Support website at [support.microsoft.com](http://support.microsoft.com) on a separate server that does not have Microsoft iSCSI Initiator or Target installed.



**NOTE:** For details about installing and configuring the iSNS server, see "Appendix" on page 39.



# Before Setting Up the PowerVault Storage Solution as an iSCSI Target

Before you set up your storage solution as an iSCSI Target, read this section completely. You must consider features such as Ethernet settings and security settings for iSCSI Targets.

## Best Practices for Setting Up the iSCSI Storage Area Network

Table 1-1 provides information about configuring NICs (on Target) in different models of iSCSI networks.

- You can configure redundant paths on Initiator (hosts). Microsoft Multipath I/O (MPIO) is supported with Initiator version of 2.06 or later.
- You require two dedicated iSCSI NICs on the Target and Initiator for efficient MPIO connection in the PowerVault storage solution.
- iSCSI NIC teaming is not supported.
- You can configure Initiators with one or two dedicated NICs for iSCSI based on your requirement.



**NOTE:** Table 1-1 provides information about the iSCSI Target NIC configuration. The optimal connection information is also provided as options. You can configure the iSCSI NICs according to your network requirements.

**Table 1-1. Using a Single PowerVault Storage Solution as a Target**

Number of NICs	Details	Refer to Figure
4	NIC-1 and NIC-2 - Teamed NICs for public network NIC-3 - iSCSI dedicated traffic (subnet A) NIC-4 - iSCSI dedicated traffic (subnet B)	Figure 1-1
3	NIC-1 - NIC for public Network NIC-2 - iSCSI dedicated traffic (subnet A) NIC-3 - iSCSI dedicated traffic (subnet B)	Figure 1-2

**NOTE:** Use this configuration if iSCSI traffic has more priority than file traffic.

- It is a good practice to have two ports dedicated for iSCSI. Configure each NIC (or ports if you have a multiport NIC) on a separate subnet.
- Secured iSCSI is possible with Challenge-Handshake Authentication Protocol (CHAP). For more information about CHAP settings, see "Configuring Secured iSCSI Connections Using Challenge-Handshake Authentication Protocol" on page 35.

**Table 1-2. Worksheet**

	<b>Options</b>	<b>Host IP</b>	<b>Target IP</b>
NIC 1	iSCSI		
	Public		
	Other		
NIC 2	iSCSI		
	Public		
	Other		
NIC 3	iSCSI		
	Public		
	Other		
NIC 4	iSCSI		
	Public		
	Other		





**NOTE:** IQNs are the standard naming convention for identifying Targets and Initiators and it is recommended that you use IQN as the identifier whenever possible.

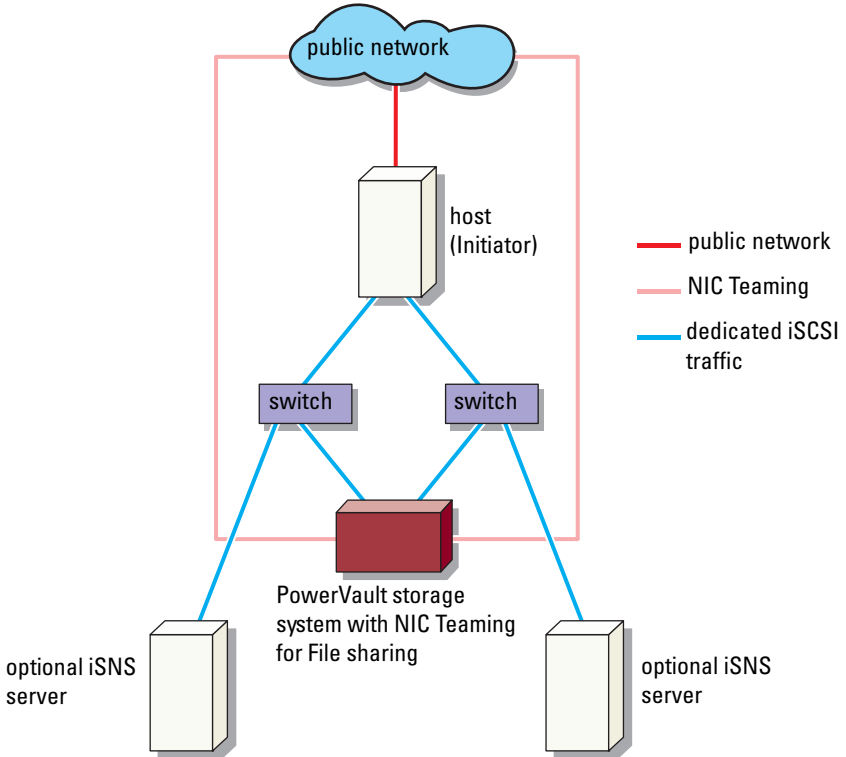

**NOTE:** It is recommended that you configure dedicated iSCSI NICs on separate subnets and not on the public network.

**Figure 1-1. Redundant iSCSI Paths and NIC Teaming for Data Sharing With Four NICs**



 **NOTE:** For a detailed configuration of the iSCSI Target, see "Target Details" on page 21.

**Figure 1-2. Redundant iSCSI Paths With Three NICs**

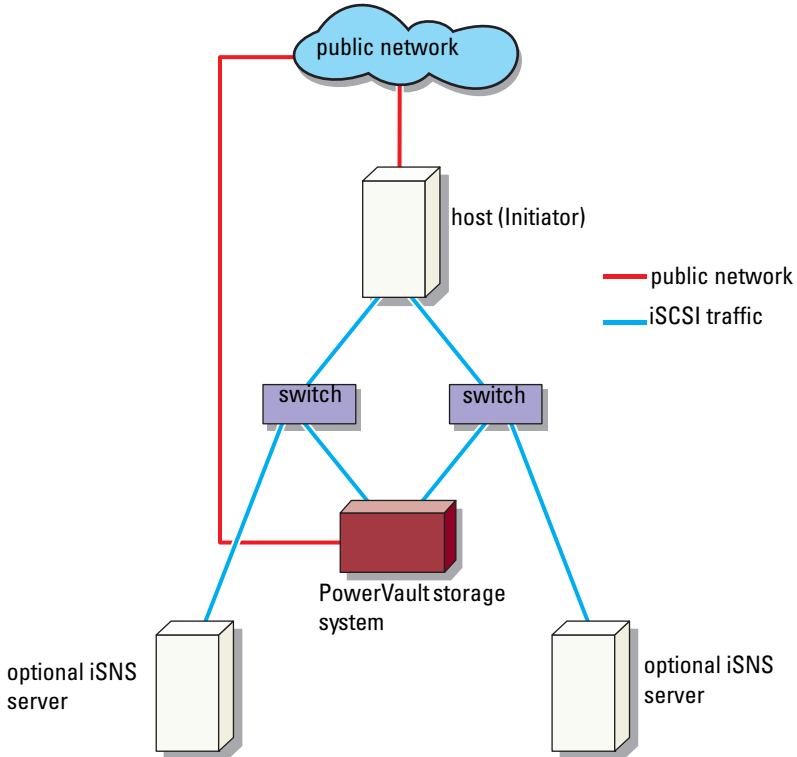

 **NOTE:** For a detailed configuration of the iSCSI Target, see "Target Details" on page 21.

# Setup Steps for Initiator-Target Connection

This section provides step-by-step instructions to set up an iSCSI Target and establish connection from an Initiator. It is assumed that the user is familiar with the following:

- Operations of iSCSI protocol
- iSCSI Initiator-Target connection information
- Install and setup of Microsoft® iSCSI Initiator, Microsoft Software iSCSI Target, and Microsoft iSNS server

## Pre-Requisites

Before you set up the iSCSI Target, ensure that you perform the following steps:

- 1 Download the latest Microsoft iSCSI Initiator software from Microsoft support website at [support.microsoft.com](http://support.microsoft.com) and install the Initiator (Host).
- 2 Install MS Software iSCSI Target on your storage system from the CD provided.
- 3 Configure and assign the IP addresses for iSCSI network using the "Worksheet" on page 10.

Before configuring iSCSI Targets, ensure that you perform the following tasks:

- 1 Create a few LUNs and reserve storage space to create virtual disks for iSCSI Targets.
- 2 Right-click **iSCSI Target** and select **Properties** to configure dedicated iSCSI NICs for iSCSI traffic (see Figure 3-1 "Creating iSCSI Targets" on page 23).

## Method 1 (Discovery Using Target Portals)

To perform Target discovery, enter the IP address of one of the NICs of the PowerVault storage system that is configured for iSCSI traffic in the Initiator and thereby enabling the Initiator to discover all Targets of this Target server.

The following steps guide you through setting up an iSCSI Target and establishing connection from an Initiator.

### Configuring the Initiator (Host)

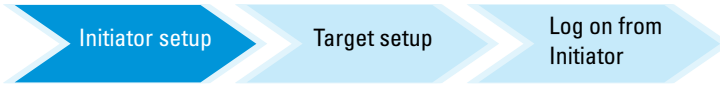

Configure the Microsoft iSCSI Initiator with the IP address of the Target server's information. To configure the Initiator:

- 1 Go to the system that has Microsoft iSCSI Initiator installed.
- 2 Click **Start**→ **Programs**→ **Microsoft iSCSI Initiator**→ **iSCSI Initiator Properties**→ **Discovery** tab.
- 3 Select **Add portal**.
- 4 Add the IP address of one of the NICs on the PowerVault storage system that is configured for iSCSI traffic (see Figure 1-1).
- 5 Click **OK**.

### Configuring iSCSI Connection With the PowerVault NAS Storage System



#### Creating the Target

- 1 From the PowerVault NAS appliance, select **Start**→ **Server Manager**→ **Storage**→ **MS Software Target**.
- 2 Select **Microsoft iSCSI Software Target** icon.  
The following options are displayed—**iSCSI Targets**, **Devices**, and **Snapshots**.
- 3 Select **iSCSI Targets** and either right-click or select the **More Actions** option in the **Actions** tab.
- 4 Select the **Create iSCSI Target** option.
- 5 The **Welcome to the Create iSCSI Target** wizard screen is displayed. Select **Next**.  
The wizard guides you through the process of Target creation.

- 6 The **Create iSCSI Target** wizard displays the **iSCSI Target Identification** option. Enter a **Name** and **Description** (optional) for the iSCSI Target and click **Next**. The **iSCSI Initiators Identifiers** screen appears.
- 7 Click **Browse** and select the **IQN** for the host that connects to the Target. The host is listed only if step 1 in "Configuring the Initiator (Host)" on page 14 was completed successfully.



**NOTE:** You must fill the IQN identifier field. You can type the Initiator IQN identifier or use the **Browse** and **Advanced** options in the screen to add the IQN identifier. For more information about the **Browse** option, see step 8. For more information about the **Advanced** option, see step 9.

- 8 If you choose the **Browse** option, you can select the **IQN identifier** by performing the following steps:
  - a Select **Browse** and the **Add iSCSI Initiator** screen appears.
  - b The details for iSCSI Initiator list is displayed. You can type or select iSCSI Initiator from the list, enter the iSCSI Initiator Name, and select **OK**. The **IQN identifier** field in the **iSCSI Initiators Identifiers** screen is populated with the value entered or selected. Select **Next**. Go to step 10.
- 9 If you choose the **Advanced** option, you can select the **IQN identifier** by performing the following steps:
  - a When you choose the **Advanced..** option, the **Advanced Identifiers** screen appears and displays the **Add** option. Select **Add**.
  - b The **Add/Edit Identifier** appears and provides four options namely—**IQN**, **DNS Domain Name**, **IP address**, and **MAC Address** to add the **IQN identifier**. Choose any one of the four options.
  - c Type in the value or choose the value through the **Browse** option, and then select **OK**.

The **IQN identifier** is displayed in the **Advanced Identifiers** screen and the fields **IQN**, **DNS Domain Name**, **IP address**, and **MAC Address** are populated.
  - d Select the populated value and select **OK**.
  - e In the **iSCSI Initiator Identifiers** screen, the **IQN identifier** field is populated with appropriate information. Click **Advanced** to view alternate identifiers.

f Select Next.



**NOTE:** IQNs work regardless of the DNS configuration. You can also specify the IP address or MAC address of the Initiator regardless of DNS configuration.

The option of specifying a DNS domain name is built into the iSCSI Software Target snap-in. While using DNS names, you must configure DNS correctly (including forward and reverse lookup zones) and specify the fully qualified domain name (FQDN) of the Initiator. If you are unable to connect the Target to the Initiator after specifying the Initiator FQDN, run the `nslookup InitiatorIP` command on the target server to verify if reverse lookup is enabled correctly.

If the `nslookup` command fails, it indicates that the DNS reverse lookup is not configured. In such a case, reconfigure the Target to use the Initiator IQN, IP address, or MAC address.

10 The Completing the Create iSCSI Target wizard appears. Click Finish.

## Creating a Virtual Disk

- 1 Right-click the newly created Target and click **Create Virtual Disk for iSCSI Target**. The **Create Virtual Disk** wizard appears. Select **Next**.
- 2 To create a file, choose the **Browse** option, select a volume on the storage array and type a file name with an extension `.vhd`.

For example, create `Z:\voll.vhd`, where Z is the mounted volume from storage array and `voll.vhd` is the filename. Select **Next**.

- 3 In the **Size** screen, choose the appropriate size from **Currently available free space** and click **Next**.
- 4 The **Description** screen may appear. Enter the virtual disk description, if required and click **Next**.
- 5 In the **Add** screen, select the Target name and click **Next**.
- 6 The **Completing the Create Virtual Disk** wizard appears. Click **Finish**.



**CAUTION:** If multiple hosts access the same Target, data corruption may occur. For more information, see "Enabling Multi-Path on the Initiator" on page 45.



**NOTE:** You can create multiple VHDs on the same volume.



## Log on - Configuring the Initiator-Target Connection From Initiator (Host)

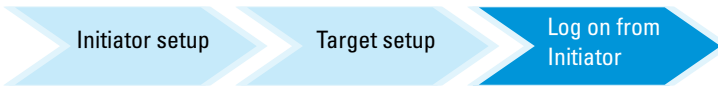

- 1 From the iSCSI Initiator (host), click **Start**→ **Programs**→ **Microsoft iSCSI Initiator**→ **iSCSI Initiator Properties**→ **Targets** tab.
- 2 Refresh the screen. The PowerVault storage system Target device that you created in "Configuring iSCSI Connection With the PowerVault NAS Storage System" on page 14 is displayed in the IQN name format.
- 3 In the **Log On to Target** window, select **Logon**, **Automatically restore** and **Enable multi-path** options.
- 4 Click **Advanced**. In the **Advanced Settings** window, select **General** tab and select the following options from drop-down menu:
  - **Local adapter**—Microsoft iSCSI Initiator
  - **Source IP**—One of the host I/P addresses that is used for iSCSI traffic
  - **Target Portal**—PowerVault storage solution's iSCSI IP address
- 5 In the **Advanced Settings** window, click **OK**.
- 6 In the **Log On to Target** window, click **OK**.

The **Targets** tab displays the status of the Target as **Connected**.
- 7 To accomplish Multipathing, you can use Microsoft MPIO to establish multiple sessions from host to the same Target device. To establish multiple sessions:
  - a Go to the **Targets** tab and select the Target that is **Connected**.
  - b Repeat step 1 to step 5.
  - c Click **Advanced Settings**. In the **Target Portal** address, choose the redundant host IP address and the IP address of the PowerVault storage solution.



**NOTE:** During the iSCSI Initiator software installation, Microsoft MPIO is already selected. MPIO is supported with Initiator version of 2.06 or later. You require two dedicated iSCSI NICs in the Target and Initiator for efficient MPIO connection. Multiple connections per session (MC/S) is not supported on the PowerVault storage solution.

- 8 To initialize and configure the iSCSI device as local drive and perform iSCSI I/O operations, select **Computer Management**→**Disk Management** option.



**CAUTION:** If multiple hosts access the same Target, data corruption may occur. For more information, see "Enabling Multi-Path on the Initiator" on page 45.

## Method 2 (Discovery Using iSNS Server)

This section describes the procedure for iSCSI Target discovery using the iSNS server. For more information about the iSNS server, see "Appendix" on page 39.

### Pre-Requisites

Before you perform iSCSI Target discovery, perform the following steps:

- 1 Identify a system to serve as an iSNS server.
- 2 Ensure that the Initiator and the Target are on the same network as the iSNS server (see Figure 1-1 and Figure 1-2).
- 3 Download the Microsoft iSCSI Initiator software from Microsoft Support website at [support.microsoft.com](http://support.microsoft.com) and install the Initiator (Host).
- 4 Download the Microsoft iSNS server software from Microsoft Support website at [support.microsoft.com](http://support.microsoft.com) and install the software on a client/server running Microsoft® Windows® operating system.  
 **NOTE:** Do not install the iSNS server software on Initiator (host) or Target (PowerVault storage solution). Install the software on a separate Client/Server running Windows operating system.
- 5 Turn on the PowerVault storage system and create one or more volumes on the storage array for creating virtual disks for iSCSI Targets.

### Configuring Settings From the Initiator

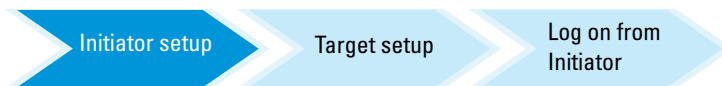

- 1 Configure the Microsoft iSCSI Initiator with iSNS server's information. Go to **Start**→**Programs**→**Administrative Tools**→**Microsoft iSCSI Initiator**→**Discovery tab**→**Add iSNS**.
- 2 Add the IP address of the iSNS server and click **OK** (see Figure 1-1 and Figure 1-2).

## Setting Up the Target (PowerVault Storage System)



- 1 From the PowerVault storage system, go to **Start**→ **Server Manager**→ **Storage**→ **Microsoft iSCSI Software Target**.

The PowerVault Server Manager Management Console appears.

- 2 Select **Microsoft iSCSI Software Target** which is located in the storage snap-in and right-click on **Properties**.
- 3 In the **Properties** window, select the **iSNS** tab and add the iSNS server information (DNS Name or IP address).

 **NOTE:** It is recommended that only NICs for iSCSI network are checked.

- 4 To create a Target, follow the instructions in "Configuring iSCSI Connection With the PowerVault NAS Storage System" on page 14.

 **NOTE:** During step 7 of Configuring the Target, use the **Browse** option to ensure that the **iSCSI Initiator Identifier** screen displays all Initiators that are registered with the iSNS server.

- 5 To create a virtual disk, follow the instructions in "Creating a Virtual Disk" on page 16.

### Log on - Configuring the Initiator-Target Connection From Initiator (Host)

For information about configuring the Initiator-Target connection, see "Log on - Configuring the Initiator-Target Connection From Initiator (Host)" on page 17.



# Target Details

This section describes the end-to-end iSCSI setup, including settings for the iSCSI Initiator, Target, and establishing connections.

## Setting Up Target IP Addresses in the PowerVault™ NAS Storage Solution

Based on your system configuration (with one or two dedicated iSCSI NICs) assign IP addresses to the iSCSI NICs. Use the IP address that you assigned to the iSCSI NIC(s) in the **Target Portals** tab of the Initiator for discovery.

### Configuring Microsoft® iSCSI Software Targets

Before configuring iSCSI Targets, you must create a few LUNs and reserve storage space to create virtual disks for iSCSI Targets. The following section provides step-by-step instructions to create storage space.

- 1 Configuring network settings on the iSCSI Target device—The PowerVault NAS storage solution is configured to use DHCP for network settings by default. The PowerVault NAS storage system is designed for multi-path operations and is equipped with two RJ45 Ethernet connectors. You can add an optional additional NIC. The **PowerVault NAS Configuration tasks** window displays the basic settings.



**NOTE:** It is recommended that you configure dedicated iSCSI NICs on separate subnets and not on the public network.



**NOTE:** It is important at this point to note that the storage solution LUN size should not be confused with the size of the iSCSI Target. The iSCSI Target is configured in a later step and is associated with the storage needed for a particular application on the host server. It is recommended that the LUN size on the storage hardware be as large as reasonably possible to allow the storage subsystem to optimize the use of the physical disks underlying the LUN that is created. In this case, as shown below, we are choosing to create one LUN at the maximum size available for this hardware. This iSCSI LUN cannot accommodate the iSCSI Targets that are created later, based on the needs of the host application.

- 2 Preparing LUNs for use—The PowerVault NAS storage solution runs on a Microsoft Windows® operating system based platform. The steps to prepare LUNs for use, such as assigning a drive letter for the internal server, providing a volume name, and so on are to Windows operating system setup. The setup wizard prompts for the required information and then provides a summary screen before performing the necessary tasks to provision the storage.

The LUN is now created and ready for use. Step 3 creates iSCSI Targets and associates the iSCSI Targets with the newly-created LUN.

- 3 Configuring NICs for iSCSI traffic in the PowerVault storage solution— You must first configure dedicated iSCSI NICs for iSCSI traffic and then create iSCSI Targets.



**NOTE:** Create iSCSI Targets only after configuring the **Discovery** tab in the iSCSI Initiator

To configure dedicated iSCSI NICs:

- a Go to **PowerVault NAS Management Console**→ **iSCSI Target**.
- b Right-click the iSCSI software Target and select **Properties**.
- c In the **Microsoft iSCSI Software Target Properties** window, go to the **Network** tab. All the NICs on the PowerVault NAS storage solution are listed.
- d Click **Edit** and uncheck public and private network IP address from the list. Unchecking public and private network IP addresses from the list ensures that only the dedicated iSCSI NICs are configured for iSCSI traffic.
- e If you have an iSNS server configured in your network, go to **iSNS** tab and add the iSNS server IP address. Click **OK**.

## 4 Creating iSCSI Targets—To create an iSCSI Target:

**Figure 3-1. Creating iSCSI Targets**

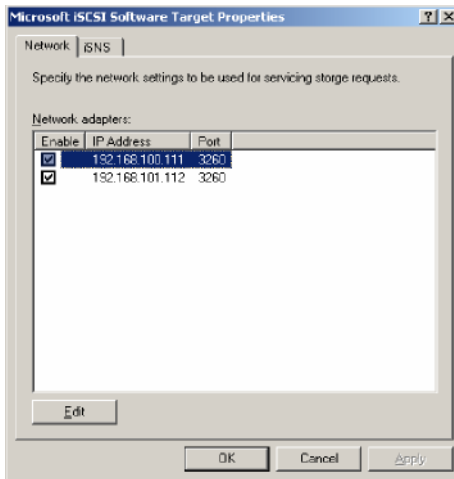

- a** In the **PowerVault NAS Management Console**, right-click **iSCSI Targets** on the left pane to launch the **Create iSCSI Target Wizard**. The **Welcome to the Create iSCSI Target Wizard** screen is displayed.
- b** Click **Next**.  
The **iSCSI Target identification** screen is displayed.
- c** Enter the **Target name** and **Description**. You can use the **Browse** option to view and choose the servers/clients in the network. The **iSCSI initiators identifiers** screen is displayed. You must associate each iSCSI Target with an iSCSI Initiator. The iSCSI Initiator is the host that requests access to the storage that is represented by the iSCSI Target name.
- d** In the **iSCSI initiators identifiers** screen, enter the iSCSI Qualified Name (IQN) of the iSCSI Initiator. You can manually enter the IQN or use the **Browse** option and choose the iSCSI Initiator from the list. You can also identify the iSCSI Initiator by using the **Advanced** option. When you click **Advanced**, the **Advanced Identifiers** screen appears. In the **Advanced Identifier** screen, click **Add**, and enter the Identifier type and the specific identifying information.

- Go to **Advanced Identifier**→ **Add**→ **Add/Edit Identifier**→ **Identifier Type** and select either **IQN**, **DNS Domain Name**, **IP address**, or **MAC Address** to add the Initiator identifier. Figure A-5 uses the IP address to identify the iSCSI Initiator. You can use the **Browse** option to choose the value from the list of available **Targets**.



**NOTE:** It is recommended that you use **IQN** as the Identifier.

The **PowerVault NAS Management Console** now displays the newly-created iSCSI Target. The **PowerVault NAS Management Console** also displays the devices available for the iSCSI Targets. The storage that are used by the iSCSI Initiators (application hosts) are defined in a later step when the virtual disks are created.

- 5 **Creating and assigning virtual disks to the Target**—You must create virtual disks on the iSCSI Targets for Microsoft-based iSCSI Target solutions. The virtual disks represent the storage volumes that the iSCSI Initiators use. The maximum capacity represented by all the virtual disks on a given iSCSI Target on a Microsoft-based iSCSI Target solution is 16 terabytes (16 TB) per Target.

The following procedure describes how to create a virtual disk. In this example, a 100 GB virtual disk and a 200 GB virtual disk are created on the iSCSI Target. The iSCSI Initiators identify these two virtual disks as volumes over the TCP/IP network.

- a Right-click on the Target name to launch the **Create Virtual Disk Wizard**.
- b Click **Next**. The **File** screen appears.

Create the virtual disk on the internal disk volume (the RAID volumes available from the attached storage array) that is available to the iSCSI Target.



**NOTE:** In the **File** screen, use the **Browse** option to choose the internal disk volume using **browse** and enter a name for virtual disk file with a **.vhd** extension.

- c Click **Next**. The **Size** screen is displayed.

The size of the virtual disk depends on the needs of the application on the host server.



- d** Choose the size for the virtual disk and click **Next**. For this example, we choose a size of 100 GB from the available 501 GB on this volume. The **Description** screen appears.
- e** The **Description** field is optional. However, enter a description for better management.
- f** Click **Next**. The **Access** screen appears.
- g** Click **Add** and enter the iSCSI Target information.  
You must associate the virtual disk with an iSCSI Target for the application host to use the virtual disk as an iSCSI storage volume.
- h** Click **Next**. The **Completing the Create Virtual Disk Wizard** appears indicating the successful completion of the virtual disk creation.
- i** Repeat step a through step h to create an additional virtual disk.

After configuring the virtual disks, the **PowerVault NAS Management Console** displays the virtual disks associated with the iSCSI Target.

The **iSCSI Target device** view displays the total volume size and the free space on the device (RAID volume) that is available for iSCSI Targets.

The iSCSI Target configuration is now complete.

## Configuring Devices

You can perform all operations related to virtual disks (devices) using the following options in **PowerVault NAS Management Console**:

- **Create/Delete Virtual Disk**—Virtual disks are represented with a **.vhd** extension. You can create or delete virtual disks using this option.
- **Extend Virtual Disk**—You can dynamically increase the size of an iSCSI virtual disk without losing data and without restarting the iSCSI Target.
- **Import**—You can import the old virtual disks, existing virtual disks previously created on the same server or another server. This feature is useful during software upgrades.
- **Disable**—You can temporarily take the virtual disk offline and can bring the virtual disk back online with the **Enable** option.
- **Assign/Remove Target**—Associate virtual disk with one or more targets, remove the existing association.

- Create Snapshot—You can take a snapshot of the virtual disk contents at any given instance.
- Disk Access—Mount Read/Write (Provision of Read/Write access of the virtual disk by mounting it as a volume in the PowerVault NAS storage system. Mounted virtual disk appears as a local disk).

 **CAUTION: Before mounting the virtual disk, disconnect all iSCSI Targets using the same virtual disk. Failure to do so can cause data corruption.**

 **NOTE:** Load balancing and failover is possible by using Microsoft MPIO support or Multiple Connections per Session (MC/S). Currently, only the MPIO option is supported with PowerVault NAS storage solution configured with 3.2 iSCSI Target and Microsoft iSCSI Initiator version 2.06 or later. The MC/S option is not supported with PowerVault NAS storage system.

## Configuring iSCSI LUNs

- 1 From Disk Management, configure the iSCSI Target device. Go to the iSCSI Initiator host and click **Start** → **Control Panel** → **Administrative tools** → **Computer Management** → **Disk Management**.

In the right pane, the iSCSI disk is displayed as **Unknown Not Initialized** and **Unallocated**.

- 2 The **Welcome to the Initialize and Convert Disk Wizard** option appears. Run the **Initialize and Convert Disk Wizard**.
  - a Retain the default settings and select **Next** in all screens.
  - b The **Completing the Initialize and Convert Disk Wizard** screen appears. Click **Finish**.

 **NOTE:** Dynamic disks are not supported with iSCSI configuration.

- 3 Go to **Disk Management**. The **Unallocated** iSCSI disk is now identified as **Basic** and **Unallocated**. Right-click the iSCSI disk and select **New Partition....**
  - a The **New Partition Wizard** is launched. Click **Next**.
  - b In the **Select Partition Type** screen, select the **Partition Type** as **Primary Partition**. Click **Next**.
  - c In the **Specify Partition size** screen, specify the partition size. Click **Next**.

- d In the **Assign Drive Letter or Path** screen, assign the driver letter from drop-down menu. Click **Next**.
- e In the **Format Partition** screen, use the default options to format the partition. Enter a Volume label and click **Next**.

 **NOTE:** Select the **Perform quick format** check box for faster Format.

- f In the **Completing the New Partition Wizard** screen, click **Finish**. The new partition is successfully created.

- 4 Go to the **Disk Management**. The iSCSI disk is identified with the volume label you entered.

 **NOTE:** Dynamic Disks are not supported with iSCSI.

## Multiple Sessions

You can create multiple sessions with different Initiator-Target combinations in different devices.

- You can configure one Initiator to access different iSCSI Targets of multiple PowerVault NAS storage systems.
- You can configure multiple Initiators to access different iSCSI Targets of same or different PowerVault NAS storage systems.
- You cannot configure multiple Initiators to access the same iSCSI Target of a PowerVault NAS storage solution.

 **CAUTION:** Accessing the same Target device using multiple iSCSI Initiators with 3.2 iSCSI Target is not supported, as it requires host clustering which is not supported. An attempt to access the same Target device using multiple iSCSI Initiators with 3.2 iSCSI Target may lead to data corruption.

## iSCSI Snapshots

You can use Microsoft iSCSI Software Target to create and manage snapshots as part of a comprehensive backup and recovery system. Snapshots are shadow copies that are built using the Volume Shadow Copy Service (VSS) technology.

To automate the creation of snapshots and the mounting of iSCSI virtual disks for regular backup, you can use the **Schedule Snapshot Wizard**. Snapshots of virtual disks that reside on an NTFS file system volume are persistent, which means they remain after a system restart.

Snapshots that are created on the iSCSI Target server are crash consistent. iSCSI snapshots are created using VSS and a storage array with a hardware provider designed for use with VSS. To enable consistent snapshots in Microsoft iSCSI Software Target, you require the Microsoft iSCSI Software Target VSS Hardware Provider. The Microsoft iSCSI Software Target VSS Hardware Provider is available as an installation option in iSCSI Software Target. The hardware provider coordinates with the local VSS to create a consistent image of the volume that can be transported to a central backup server.

In a PowerVault storage system, you can create an iSCSI snapshot in two ways:

- Manually create a snapshot of a single virtual disk in the Microsoft iSCSI Software Target console.
- Use the **Schedule Snapshot Wizard** to set up a schedule for creating a single snapshot or recurring snapshots automatically.

### Before Creating Snapshots

Before creating snapshots for virtual disks, perform the following steps:



**NOTE:** Use Windows Explorer and go to the volume that contains the virtual disks that you are creating snapshots for.

- 1 Go to **Volume**→**Properties**→**Shadow Copies**→**Settings**. Ensure that the **Located on this volume** option in the **Storage Area** tab displays the same drive letter as that of the volume.
- 2 Click **Details** to verify the volume usage. The default settings are as follows:
  - **Maximum size**
  - **Use limit**—size in MB or **No Limit**

Change the size according to virtual disk/snapshot size or change the settings to **No Limit**.



**CAUTION:** Ensure that you have enough space in the volume to hold virtual disk snapshots. If there is not enough space, the snapshots are lost.

3 After making necessary changes, click **OK**.



**CAUTION:** Even if you do not change the default settings, go to **Volume**→**Properties**→**Shadow Copies**→**Settings** and click **OK**. Perform this action to ensure proper snapshot recovery in the event of node failure. When the snapshot size exceeds the maximum size of the storage area, the oldest snapshot is deleted.



**NOTE:** Each volume can have up to 512 snapshots for iSCSI virtual disks, irrespective of the number of virtual disks created in the volume. Snapshots are space efficient because they are differential copies.

### Scheduling Snapshots

To schedule snapshots for iSCSI virtual disks:

1 Go to **PowerVault NAS Management Console**→**Microsoft iSCSI Software Target**.

2 Go to the **Snapshots** tab, right-click **Schedules**, and select **Create Schedule**.

The **Welcome to the Schedule Snapshot Wizard** screen is displayed.

3 Click **Next**.

4 The **Schedule Actions** screen is displayed and the following options are available:

Take snapshots of the **Virtual Disks** (default)

Take snapshots of the **Virtual Disks** and mount the snapshots locally

Select one option and click **Next**.

5 In the **Name** screen, enter a schedule name and click **Next**.

6 The **Virtual Disks** screen appears and displays the following options:

Include all **Virtual Disks** (default)

Include only the selected **Virtual Disks**

You can select all or selected virtual disks for snapshots.



**NOTE:** In a PowerVault NAS storage solution, all virtual disks are listed in the **Virtual Disks** screen.

- 7 The **Frequency** screen appears and lists the different options namely—**Daily**, **Weekly**, **Monthly**, and **On-time only**. Choose one option and click **Next**.
- 8 You must select the **Start Time**, **Days**, **Months**, **Start Date**, and other time parameters based on the Frequency selection in step 7. Edit these parameters to the preferred time. Click **Next**.  
 **NOTE:** You can modify the snapshot schedule later.
- 9 The **Completing the Schedule Snapshot Wizard** screen is displayed. Click **Finish**.

### Verifying Scheduling Snapshots (Optional)

After you schedule the creation of snapshots, go to the **PowerVault NAS Management Console**→**Microsoft iSCSI Software Target**→**Snapshots**→**Schedules** and verify that Schedule name, current run, next run with time-stamping are displayed in the middle-pane.

### Active Snapshots

After scheduling the creation of snapshots, go to the **Active Snapshots** tab. All snapshot details including the Source Virtual Disk, Time stamp, and the Export status are listed in the middle-pane.

You can use the **Active Snapshots** tab to export, delete, roll back, and mount active snapshots like a local disk.

- Export Snapshot—Use this option to make a snapshot available to a remote system or to take a redundant copy of a snapshot. Use the **Export Snapshot** wizard to export the snapshot to one or more iSCSI Targets. The snapshot can then be accessed by Initiators (read-only access). To export a snapshot:
  - a Go to the **Active Snapshots** tab, select the snapshot that you want to export from the middle-pane, right-click and select **Export Snapshot**.
  - b The **Welcome to the Export Snapshot Wizard** appears. Click **Next**.
  - c In the **Snapshot Access** screen, add the Targets that you want to grant read-only access to this snapshot. Click **Next**.
  - d Click **Finish**.
  - e Go to the Target and verify that this snapshot has been added as a virtual disk.

- Delete snapshot—Select the snapshot that you want to delete, right-click the snapshot and click **Delete**.



**NOTE:** You cannot delete the snapshots that are mounted. You must dismount the snapshot before deleting it.

- Disk Access—You can mount the snapshot of an iSCSI virtual disk in read -only mode from the PowerVault NAS storage system and it appears as a local disk.



**CAUTION:** While dismounting a snapshot/virtual disk, ensure that the disk is not in use. Failure to do so may cause data corruption.



**NOTE:** You can either mount iSCSI virtual disk (read/write or read/only) or its snapshot (read-only), but not both. If you have mounted virtual disk and perform a subsequent mount operation of snapshot, the previous instance is dismounted before proceeding.

- Rollback—Use this option to roll back an iSCSI virtual disk to a previous snapshot. This operation uses the **temp** directory located at **C:\Windows\Temp**. Ensure that the **temp** directory contains sufficient space to store the differential data. The rollback fails if enough space is not available.
  - a Right-click on the snapshot and select **Rollback to snapshot**. In the pop-up message, select **Yes**.
  - b To check the status of rollback, go to the **Devices** tab. The rollback progress is displayed in % (percentage) in the Virtual Disk section of the middle-pane.
  - c You can also abort a rollback operation. Abort a roll back, if you can rollback to a different snapshot. Otherwise it is highly recommended that you allow the rollback to complete.



**NOTE:** If you roll back, all data on the current virtual disk is lost. Disconnect all iSCSI Targets from the Initiator that are using this virtual disk. If the virtual disk is mounted as a read/write disk, dismount the virtual disk before the rollback.

# Disconnecting/Cleaning Up iSCSI Devices

This section describes the procedure for cleanup operations to be performed on iSCSI devices. You must perform the procedure for cleanup operations on both iSCSI Target and iSCSI Initiator.

## From Initiator

Disconnect an active connection with the Target by stopping the iSCSI I/O operations that are running on that Target device by performing the following steps:

- 1 Click **Start**→ **All Programs**→ **Microsoft iSCSI Initiator**→ **iSCSI Initiator Properties**→ **Targets** tab.
- 2 Select the Target that is **Connected** and click **Details**.
- 3 The **Target Properties** screen appears. In the **Sessions** tab, select the check box beside the Identifier and click **Logoff**. The connection is disconnected.
- 4 In the **iSCSI Initiator Properties** screen, click the **Persistent Targets** tab and remove entries of persistent Targets.
- 5 If you want to remove Target IQN name entries, go to the **Discovery** tab and remove the IP address/DNS name of the PowerVault NAS storage system in the **Target Portals** section or remove the IP address/DNS name entry of the iSNS server.
- 6 Go to the **Targets** tab and click **Refresh**. The Target IQN name is not listed.

## From Target

To remove virtual disks from the iSCSI Target, delete virtual disks by performing the following steps:

- 1 Go to **PowerVault NAS Management Console**→ **Microsoft iSCSI Software Target**→ **iSCSI Targets**. Select the Target and the associated virtual disks to be deleted.
  - a The middle pane lists all virtual disks. Right-click the virtual disk to be deleted and select the **Remove Virtual Disk From iSCSI Target** option.
  - b Repeat step a for all virtual disks associated with this Target.
- 2 To delete a Target, right-click on the Target, and select the **Delete iSCSI Target** option. Manually browse to locate the **.vhd** file associated with the Target and delete it.



- 3 To delete a virtual disk, choose the **Devices** option, right-click on the virtual disk from middle pane, and select **Delete Virtual Disk**.



**NOTE:** Step 3 only deletes the association in the iSCSI Target software, but does not clear the disk space in the volume. You must manually browse to the volume and delete the .vhd file to clear the disk space.

- 4 To remove an iSNS server entry, right-click **Microsoft iSCSI Software Target**→ select **Properties**→ **iSNS** tab → **Remove the DNS name or IP address entry**.



# Configuring Secured iSCSI Connections Using Challenge-Handshake Authentication Protocol

Few security features for the iSCSI protocol are included in the iSCSI layer itself, apart from any security layers that may be present in the lower TCP/IP and Ethernet layers. You can enable and disable the iSCSI security features as required.

The Microsoft® iSCSI Initiator uses the Challenge-Handshake Authentication Protocol (CHAP) to verify the identity of iSCSI host systems attempting to access iSCSI Targets. The iSCSI Initiator and iSCSI Target use CHAP and share a predefined secret. The Initiator combines the secret with other information into a value and calculates a one-way hash using the Message Digest 5 (MD5) function. The hash value is transmitted to the Target. The Target computes a one-way hash of its shared secret and other information. If the hash values match, the Initiator is authenticated. The other security information includes an ID value that is increased with each CHAP dialog to protect against replay attacks. The Dell™ PowerVault™ NAS storage solution also supports Mutual CHAP.

CHAP is generally regarded as more secure than Password Authentication Protocol (PAP).

## CHAP vs IPsec

CHAP authenticates the peer of a connection and is based upon the peers sharing a secret (a security key that is similar to a password). IP Security (IPsec) is a protocol that enforces authentication and data encryption at the IP packet layer and provides an additional level of security.

## One-Way CHAP Authentication

In one-way CHAP authentication, only the iSCSI Target authenticates the Initiator. The secret is set only for the Target and all Initiators that are accessing the Target must use the same secret to start a logon session with the Target. To set one-way CHAP authentication, configure the settings described in the following sections on Target and Initiator.

### iSCSI Target Settings

Before you configure the settings described in this section, ensure that few iSCSI Targets and Virtual Disks are already created and the Virtual Disks are assigned to the Targets.

- 1 On an iSCSI Target, go to **PowerVault NAS Management Console**→ **Microsoft iSCSI Software Target**→ **iSCSI Targets**→ <Target name> and either right-click and select **Properties** or go to **Actions** pane→ **More Actions**→ **Properties**.

The <Target Name> **Properties** window appears, where *Target Name* is the name of the iSCSI Target that you are configuring iSCSI settings for.

- 2 In the **Authentication** tab, select the check box for **Enable CHAP** and type the user name (IQN name of the Initiator). You can enter the IQN manually or use the **Browse** option to select the IQN from a list.
- 3 Enter the **Secret**, re-enter the same value in **Confirm Secret**, and click **OK**. The secret must include 12 to 16 characters.



**NOTE:** If you are not using IPsec, both Initiator and Target CHAP secrets should be greater than or equal to 12 bytes and less than or equal to 16 bytes. If you are using IPsec, the Initiator and Target secrets must be greater than 1 byte and less than or equal to 16 bytes.

## iSCSI Initiator Settings

- 1 Go to the **Discovery** tab.
- 2 Log in to the Target on which you have enabled CHAP by clicking **iSCSI Initiator Properties**→**Targets** tab→**Log On....** (Please refer "iSCSI Target Settings" on page 36).
- 3 In the **Log On to Target** window, select **Advanced**.
- 4 In the **Advanced Settings** window, select the check box for **CHAP logon information**.

The **User name** fields displays the IQN of the Initiator automatically.

- 5 In the **Target secret** field enter the same value of the target secret that you set in the iSCSI Target and click **OK**.

If the Target secret value is correct, you are logged on to the Target. Otherwise the logon fails along with authentication failure.

## Mutual CHAP Authentication

When you use mutual CHAP authentication, the Target and the Initiator authenticate each other. A separate secret is set for each Target and for each Initiator in the storage area network (SAN).

### Initiator Settings

- 1 On the iSCSI Initiator, go to the **iSCSI Initiator Properties**→**General** tab→**Secret** button.
- 2 The **CHAP Secret Setup** screen appears. In the **Enter a secure secret** field, enter a secret code that includes 12 to 16 characters and click **OK**.

 **NOTE:** This Initiator CHAP secret and the Target CHAP secret must be different.

- 3 Before you can log on to the Target, you must set the Initiator CHAP secret in the Target. Therefore, you must complete Target settings and then log on to the iSCSI Initiator.

## Target Settings

Configure the Target settings of CHAP as described in "iSCSI Target Settings" on page 36 and perform the following steps:

- 1 In the <Target Name> **Properties** window, select the **Authentication** tab.
- 2 Select the check box for **Enable reverse CHAP authentication**. In the **User name** field, enter the **IQN** of the Initiator.
- 3 In the **Reverse secret** field enter the **Secret** value that you set in the Initiator.



**NOTE:** Ensure that the reverse secret is not the same as the CHAP secret. The reverse secret must contain 12 to 16 characters.

## Initiator Settings Continued

- 1 Configure the Initiator settings for CHAP as described in "iSCSI Initiator Settings" on page 37.
- 2 In the **Advanced Settings** window→ select **CHAP logon information**→ enter the **User name** and **Target secret**. Select the check box for **Perform mutual authentication** and click **OK**.

You can log in only if you have credentials that you entered for the Target and Initiator.

# A

## Appendix

The previous chapters in this document describe the procedures for basic iSCSI session/connection information. This chapter briefly describes procedures for a few advanced configuration settings.

### Initiator Details

This section describes the various features included in the **iSCSI Initiator Properties** window.

#### General Tab

The **General** tab displays the Initiator node name which is the Initiator's iSCSI Qualified Name (IQN).

**Figure A-1. General Tab in iSCSI Initiator Properties Window**

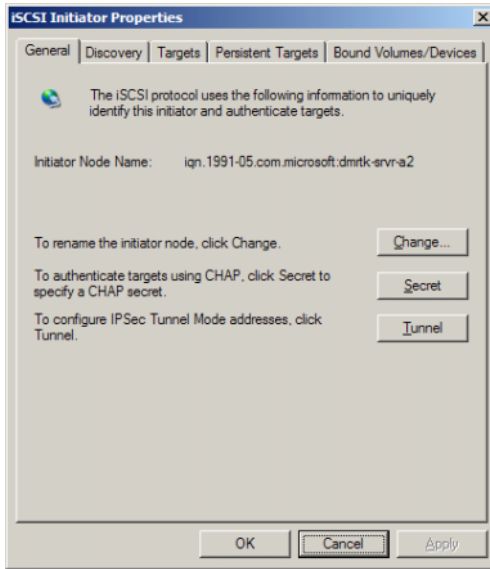

The **General** tab includes three options namely—**Change**, **Secret** and **Tunnel**.

- **Change**—Allows you to rename the Initiator node name that is displayed.
- **Secret**—iSCSI security provided CHAP. For more information, see "Configuring Secured iSCSI Connections Using Challenge-Handshake Authentication Protocol" on page 35.
- **Tunnel**—You can use this option for advanced configuration using IPsec.

### **Discovery Tab**

**Target Portals**—The **Discovery** tab provides the list of discovered iSCSI Target portals available to the Initiator. The Target portal is the primary IP address of the iSCSI Target solution and provides a dedicated iSCSI NIC IP address for the PowerVault NAS storage solution. If no Target portals are listed, you can add them using the IP address or DNS name of the Target server. In the following example, two iSCSI Target portals are already added.



**Figure A-2. Discovery Tab in iSCSI Initiator Properties Window**

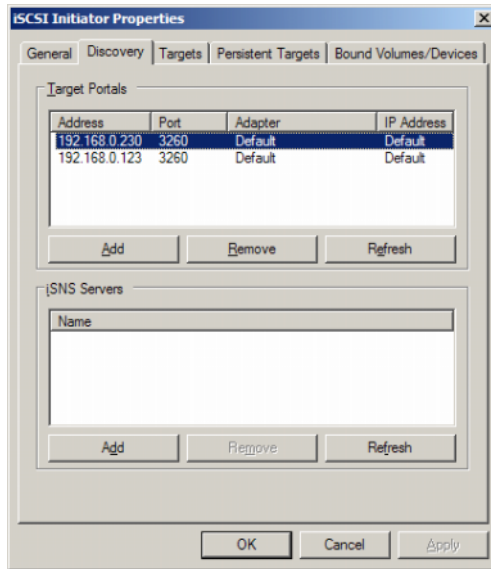

**iSNS Servers**—You can also perform Target discovery using iSNS servers.

Add the iSNS server IP address or DNS name. If the iSNS service is up and running on a server, all clients (Initiators and Targets) that are registered with the iSNS server are listed in the **Registered Clients** screen. To retrieve this information on the iSNS server, go to **Microsoft iSNS properties**→ **Registered Clients**.

## Targets Tab

The **Targets** tab provides the list of individual Targets available to the iSCSI Initiator. In the following example, three Targets are available to the iSCSI Initiator.

**Figure A-3. Targets Tab in iSCSI Initiator Properties Window**

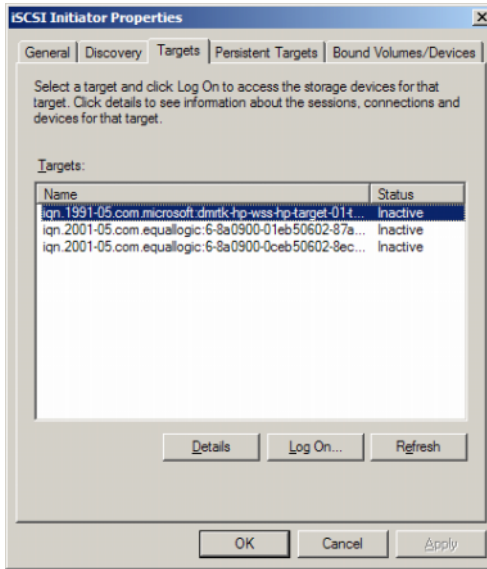

**NOTE:** The above illustration is an example of discovery in the **Targets** tab. In practice, the Targets are discovered only after you configure the PowerVault NAS storage system as a Target.

**Log On**—To gain access to the Target, the Initiator must log on to the Target. If only one path is available to the Target, only one step is required for log on. Click **Log On...**, specify the **Target name**, and then click **OK**.

If multiple-paths to the Target are available, then you must describe each path to the iSCSI Initiator. To describe multiple paths to the Initiator:

- 1 In the **Log On to Target** window, select **Enable multi-path** and click **Advanced**.

The **Advanced** option provides a drop-down menu with all possible source (Initiator) IP addresses and a separate drop-down menu for all possible Target portal addresses. In this scenario, the Target solution manages the actual paths and IP addresses internally. Other Target solutions display each available IP address that can be used for multi-path operations.

- 2 Select each desired combination of source IP address and Target IP address and login separately to have multiple sessions for the same Target device.
- 3 Select **Automatically restore this connection when the system boots** to ensure continuous connection and to avoid establishment of Target-Initiator association during power spike or system reboots.
- 4 Repeat the **Log on** process for each iSCSI NIC.

**Figure A-4. Log On to Target Window**

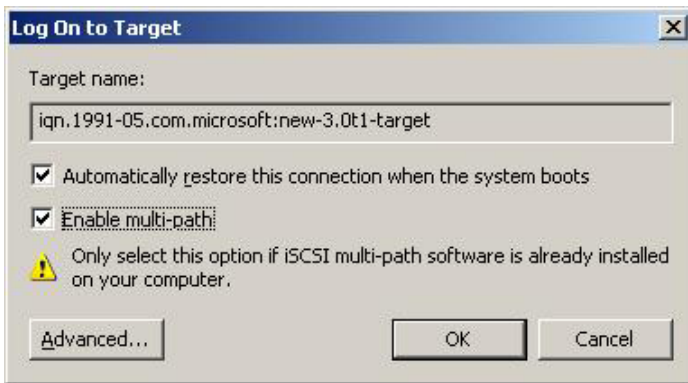

For MPIO connection, you must select the Target that displays status as **Connected** and select **Log On**. In the **Log On to Target** window, select **Advanced** and configure redundant iSCSI Target IP address.

## Persistent Targets Tab

You can configure Persistent Targets so that the connection to the Target is automatically restored when the system reboots. If the Targets are configured to be persistent, they appear in this **Persistent Targets** tab.

**Figure A-5. Persistent Targets Tab in iSCSI Initiator Properties Window**

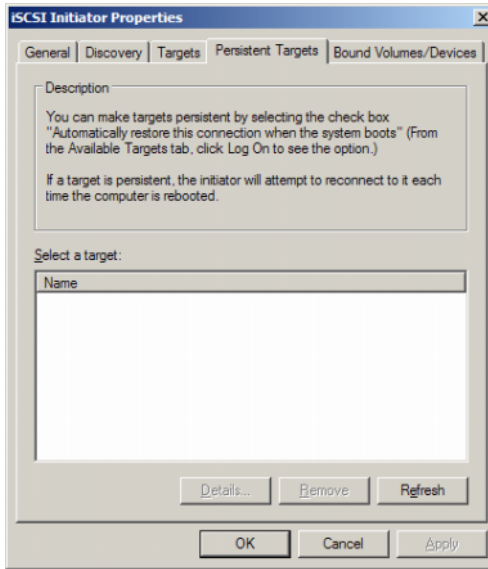

## Bound Volumes/Devices Tab

If a host service or application depends on the availability of an iSCSI volume, you must configure it as **bound** so that the iSCSI service includes each **bound** volume as part of its initialization.

**Figure A-6. Bound Volumes/Devices Tab in iSCSI Initiator Properties Window**

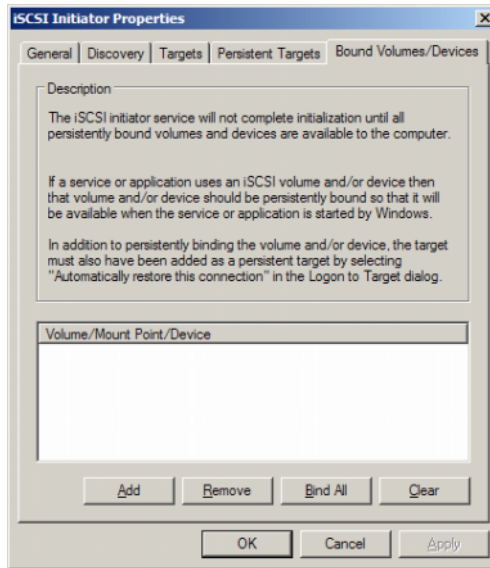

## Advanced Configuration Details

### Enabling Multi-Path on the Initiator

After you establish the iSCSI Initiator-Target connection, perform the following steps to enable multi-path operation:

- 1 On the Initiator, go to **iSCSI Initiator Properties** → **Targets** tab → **Log On...** → **Log On to Target** window and select the check box for **Enable multi-path** option.
- 2 You must configure multiple NIC ports for iSCSI operation for efficient block (iSCSI) I/O operations and for provisioning link failover. Multi-path option also enables multiple connections for the same iSCSI Targets using different IP addresses.

## Using the Advanced Option

You can use the Advanced option to perform the following functions:

- Go to **iSCSI Initiator Properties**→ **Targets** tab→ **LogOn...**→ **Log On to Target** window→ **Advanced** option. The **Advanced Settings** screen appears and consists of two tabs namely—**Advanced** and **IPSec**. The **General** tab allows you to set CRC/Checksum, CHAP and choose source IP address and Target Portal—IP address of iSCSI Target. You can use the Multi-path option to configure load balancing and failover settings.
- In the **Advanced Settings** window, the **Advanced** tab provides a drop-down menu for all the source (Initiator) IP addresses and a drop-down menu for all Target portal addresses. In an iSCSI Initiator-Target connection, the Target solution manages the actual paths and IP addresses internally. If you are using different Target solutions, you can choose the IP address for multi-path operations from the list.
  - a Log on and select the combination of source IP address and Target IP address.
  - b Log in separately to configure multiple connections for the same Target device.
- In the **Advanced Settings** window, the **IPSec** tab allows you to configure IPSec settings. If you enable IPSec, all IP packets sent during data transfers are encrypted and authenticated. A common key is set on all IP portals, allowing all peers to authenticate each other and negotiate packet encryption.

## Verifying the Properties of the Targets that are Connected

Go to **iSCSI Initiator Properties**→ **Targets**→ highlight the Target that is **Connected** and click **Details**. The **Target properties** screen is displayed and consists of three tabs namely—**Sessions**, **Devices**, and **Properties**. The following sections provide more details about these tabs.

### Sessions Tab

The **Sessions** tab provides information about the **Session Identifier**, **Session properties**, and **Sessions Connections**. This tab allows you to Log off sessions.

## Devices Tab

The **Devices** tab of **Target Properties** screen provides generic device details like the virtual disks that are associated with Target.

Click **Advanced** to view information about MPIO and launch the **Device Details** screen.

You can use the **MPIO** tab to modify the MPIO settings. On this tab, you can select the appropriate Load Balance Policy settings. You can configure Load balancing for each connection from the different Load Balance Policy options that are available. When you select each policy in the **Load Balance Policy** field of the **MPIO** tab, the following descriptions are displayed on the screen:

- **Fail Over Policy**—The fail over policy employs one active path and designates all other paths as standby. The standby paths will be tried on a round-robin approach upon failure of the active path until an available path is found.
- **Round Robin**—The round robin policy attempts to evenly distribute incoming requests to all possible paths.
- **Round Robin With Subset**—The round robin subset policy executes the round robin policy only on paths designated as active. The stand-by paths will be tried on a round-robin approach upon failure of all active paths.
- **Least Queue Depth**—The least queue depth policy compensates for uneven loads by distributing proportionately more I/O requests to lightly loaded processing paths.
- **Weighted Paths**—The weighted paths policy allows the user to specify the relative processing load of each path. A large number means that the path priority is low.

The default option is **Round Robin**. Select the required option from the **Load Balance Policy** drop-down menu to configure the Load Balance Policy and click **Apply** to confirm your setting.

## Properties Tab

The **Properties** tab of **Target Properties** screen provides information about Target Alias, Authentication, Associated Network portals and other details of the Target.

## Installing and Configuring iSNS Server

The Microsoft iSNS server is a free download from the Microsoft website at [www.microsoft.com](http://www.microsoft.com) and is available in two versions namely—x86 and IA64. You can use the iSNS Server for Target discovery on an iSCSI network.

iSNS server is supported on the Microsoft Windows 2000 Server Service Pack 4 and Microsoft Windows Server 2003 operating systems. Perform the following steps to install the iSNS server:



**NOTE:** Do not install iSNS server on the same server that is running Microsoft iSCSI Initiator.

- 1 Install Microsoft iSNS server version 3.0 or later. The Installation process is simple and is wizard-based. In the **Welcome to the Microsoft iSNS Server Setup Wizard** screen, click **Next**.
- 2 The **License Agreement** screen appears. Read the information and click **Next**.
- 3 The **Select Installation Folder** appears. Enter the folder path or choose a location on your local drive using the **Browse** option and click **Next**.
- 4 In the **Confirm Installation** screen, click **Next**.
- 5 The **Installing Microsoft iSNS Server** screen indicates the installation progress. The **Microsoft iSNS Installation Program** prompts you to choose from the **iSNS Installation Options**. Choose **Install iSNS Service** and click **OK**.
- 6 The **End User License Agreement** screen appears. Read the agreement and click **Agree** to install the program.
- 7 The **Microsoft iSNS Service Setup Program** windows indicates that the program is installed successfully.
- 8 The **Microsoft iSNS Server Information** screen appears. Read the information and click **Next**.
- 9 The **Installation Complete** screen appears indicating the completion of program installation. Click **Close**.



## Configuring the iSNS Server

iSNS server performs the automatic discovery of iSCSI Initiators and Targets; after you register them with iSNS server.

- The Initiators that are registered with iSNS servers can view all Target devices that are registered with iSNS in the **Targets** tab and log on to the Targets. You do not have to configure Initiators with the IP address or DNS name of individual Target servers in **Target Portals**. iSNS server performs Target Discovery.
- Similarly, PowerVault NAS storage system (Target) can query the available Initiators from iSNS server for association.

To configure the iSNS server, perform the following steps.

- 1** Log on to the server where you have installed the iSNS server 3.0 or later and go to **Start**→ **Programs**→ **Microsoft iSNS Server**→ **Configure iSNS Server**.

The iSNS server screen consists of three tabs namely—**General**, **Discovery Domains**, and **Discovery Domain Sets**. The **General** tab lists all devices (iSCSI Initiators and Targets) that are registered with the iSNS server. Perform the following procedure to add Targets and Initiators to the iSNS server:

- a** Go to the **iSCSI Initiator properties**→ **Discovery**→ **iSNS Servers**→ **Add** and add the IP address or DNS name of the Initiator and register this Initiator to the iSNS server.
- b** Log in to the iSNS server and go to **Start**→ **Programs**→ **Microsoft iSNS Server**→ **Configure iSNS Server**→ **General** tab. The Initiator that you registered with iSNS server in step a is listed. Similarly all iSCSI Initiators that you register with iSNS server are listed in the **General** tab.
- c** Log in to the PowerVault NAS storage solution that you configured as a Target and go to **PowerVault NAS Management Console**→ **Microsoft iSCSI Software Target**→ right-click and select **Properties**→ **iSNS** tab and add iSNS server IP address or DNS name.
- d** To verify, log in to the iSNS server and check the **General** tab to ensure that all Targets of PowerVault storage solution are listed.

If multiple PowerVault NAS storage systems are registered with iSNS server, then all Target Devices that are created in the PowerVault storage systems are listed in iSNS server.

- 2 You can use the **Discovery Domains** feature to group certain Initiators with Targets with specific access:
  - a Go to **iSNS Server Properties**→ **Discovery Domains** tab→ click **Create**→ enter a name for the Discovery domain→ select **Add**.
  - b The **Add registered Initiator or Target to Discovery Domain** screen appears. Select the specific Initiators and Targets that you want to configure and click **OK**.
- 3 You can configure multiple Discovery Domains in the iSCSI network. The domains are listed in the **Discovery Domain Sets** tab. The **Discovery Domain Sets** tab displays Default DD and Default DDS options. You can create any number of groups as required.

## Best Practices for Efficient Storage Management

### Storage Manager for SANs

Storage Manager for SANs is a Microsoft Management Console snap-in that system administrators can use to create and manage the logical unit numbers (LUNs) that are used to allocate space on storage arrays in both Fibre Channel and iSCSI environments. Storage Manager for SANs is deployed through a conventional snap-in and can be used on storage area network (SAN) based storage arrays that support Virtual Disk Server (VDS) using a hardware VDS provider. Due to hardware, protocol, transport layer and security differences, configuration and LUN management differ for the two types (iSCSI and Fibre Channel) of supported environments. This feature works with any type of Host Bus Adapter (HBA) or switches on the SAN. For a list of VDS providers that have passed the Hardware Compatibility Tests (HCT), see the Microsoft storage website on [www.microsoft.com/storage](http://www.microsoft.com/storage).

### LUN Management for iSCSI Subsystems

For iSCSI, a LUN is assigned to a Target—a logical entity that contains one or more LUNs. A server accesses the LUN by logging on to the Target using the server's iSCSI Initiator. To log on to a Target, the Initiator connects to portals on the Target; a subsystem has one or more portals, which are associated with Targets. If a server's Initiator is logged on to a Target, and a new LUN is assigned to the Target, the server can immediately access the LUN.

Securing data on an iSCSI SAN—To help secure data transfers between the server and the subsystem, configure security for the login sessions between Initiators and Targets. Using Storage Manager for SANs, you can configure one-way or mutual Challenge Handshake Authentication Protocol (CHAP) authentication between the Initiator and Targets, and you can also configure Internet Protocol security (IPsec) data encryption.



**NOTE:** It is recommended that you use CHAP if the iSCSI traffic uses the public network.

## Known Issues

- Event generated while dismounting a virtual disk—When you dismount a locally mounted virtual disk, the following event may be generated in the system log:

```
Plugplaymanager 12 event:
```

```
The device 'MSFT 00000000F852A09D SCSI Disk  
Device'
```

```
(SCSI\Disk&Ven_MSFT&Prod_00000000F852A09D\1&2afd7  
d61&3&000003) disappeared from the system without  
first being prepared for removal.
```

```
It is safe to ignore these events for normal  
Microsoft iSCSI Software Target dismount  
operations.
```

- Rollback operations on a locally mounted virtual disk—When you mount a virtual disk locally in read/write mode, any rollback operation performed on that virtual disk takes a long time to complete.
- Termination of rollback—Disabling a virtual disk during a rollback terminates the rollback operation without a warning. An event is logged documenting that the rollback was ended.
- Locally mounted virtual disks are listed in available drives—When you create a new virtual disk, the locally mounted virtual disks are displayed in the list of available volumes to host the new virtual disk. A locally mounted virtual disk does not support storing a virtual disk. If you attempt to select the locally mounted virtual disk as the storage location for the new virtual disk, the following error message is displayed:

The wizard was unable to import one or more virtual disks. Make sure that the files are not in use, and then run the wizard again.

- Initiator fails to discover a Target using the DNS domain name— When configuring Initiator access to an iSCSI Target, IQNs are the preferred method and work regardless of DNS configuration. The option of specifying a DNS domain name is built into the Microsoft iSCSI Software Target snap-in. If you prefer to use DNS names, ensure that DNS is configured correctly (including forward and reverse lookup zones) and specify the fully qualified domain name (FQDN) of the Initiator. If you have difficulty in connecting the Target to the Initiator after specifying the Initiator FQDN, run the following command on the target server to check that DNS reverse lookup is enabled correctly:

**nslookup <InitiatorIP>** where <InitiatorIP> is the IP address of the iSCSI Initiator.

If the *nslookup* command fails, it indicates that DNS reverse lookup is not configured. Reconfigure the Target to use the Initiator IQN, IP address, or MAC address. Alternatively, you can use a NetBIOS name to connect the Initiator, fulfilling the following conditions:

- No DNS reverse lookup zones are configured for the subnet used by the Target.
  - Network Discovery or File Sharing is enabled on Initiator and Target servers.
- Shadow copies of local-mounted volumes—It is recommended that you do not make shadow copies of local-mounted volumes. When you locally mount a virtual disk and then try to make a shadow copy of that volume using Windows Explorer, the storage appliance appears to hang. This is because of the way shadow copies are created. When you make a shadow copy of a locally mounted virtual disk, the local mount driver writes to the underlying volume hosting the virtual disk. This causes an additional write to the differencing area on the host volume. The result is a circular series of writes that eventually cause the storage appliance to stop responding. If you encounter this scenario, restart the storage appliance.
  - Initiator fails to restore a lost connection—The Initiator may fail to restore a lost connection due to bad IP addresses. In some cases where the iSCSI Initiator loses communication with Microsoft iSCSI Software Target, the Initiator may appear to hang while reconnecting. This issue occurs if the

server running Microsoft iSCSI Software Target has IP addresses that are not used to communicate with the Initiator. The Initiator attempts to connect to each configured IP address and waits up to 100 seconds for a response. This issue can also be caused by automatic private IP address assignments (169.x.x.x). To prevent this issue, use static IP addresses where DHCP is unavailable.

The following options provide a workaround for this issue:

- Specify the source and target portal by IP address.
- Use only IPv4 addresses or IPv6 addresses: do not mix the types of address.
- Disable network cards that are not connected to a network.
- Errors in Event Viewer—You may encounter errors in the Event Viewer when you attempt to uninstall Microsoft iSCSI Software Target 3.2 and reinstall it again. As a workaround, stop the Microsoft iSCSI Software Target service before uninstalling the software. If the software has already been uninstalled, restart the computer before reinstalling Microsoft iSCSI Software Target.
- Additional Firewall rules for iSCSI Initiators—You may need to enable additional rules to connect an iSCSI Initiator to Microsoft iSCSI Software Target on Windows Storage Server 2008. The following Windows Firewall rules are required:
  - Windows Management Instrumentation (WMI-In) [TCP/All ports]
  - Windows Management Instrumentation (DCOM-In) [TCP/Port 135]
  - Windows Management Instrumentation (ASync-In) [TCP/All ports]
  - Windows Management Instrumentation (WMI-Out) [TCP/All ports]
  - Remote Volume Management (RPC-EPMAP) [TCP/RPC Endpoint Mapper]
  - Remote Volume Management - Virtual Disk Service Loader (RPC) [TCP/Dynamic RPC]
  - Remote Volume Management - Virtual Disk Service (RPC) [TCP/Dynamic RPC]



# Index

## B

- best practices
  - setting up the iSCSI storage area network, 9

## C

- CHAP, 35
  - mutual, 37
  - one-way, 36
- configuring
  - Initiator, 18
  - Initiator (host), 14
  - Initiator-Target connection from Initiator (host), 17
  - iSCSI connection with the PowerVault storage system, 14
  - iSCSI LUNs, 21
  - settings from initiator, 18

## D

- disconnecting/cleaning
  - iSCSI devices, 32

## I

- iSCSI, 8

- iSCSI snapshots, 27

- iSNS, 8

## K

- known issues, 51

## P

- PowerVault storage system, 8

## S

- setting up
  - target, 18

## W

- worksheet, 10

